

# Vision 2000 Pop-Up Display System

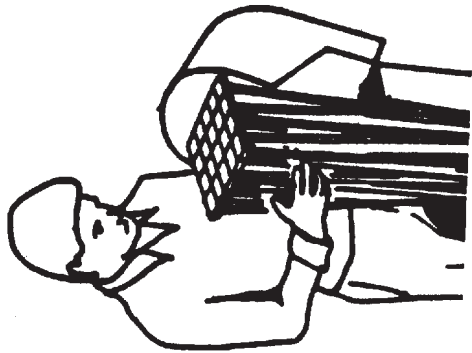

## SET UP INSTRUCTIONS

1. Your display comes in either one oval case or two semi-oval cases. Unpack the frame and channel bars.

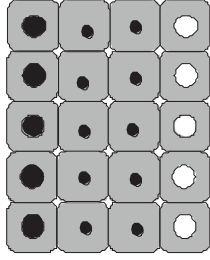

2. Expand the frame. Make sure the frame is right side up - the row of large black buttons is at the top of the frame while the row of large white buttons is at the bottom of the frame.

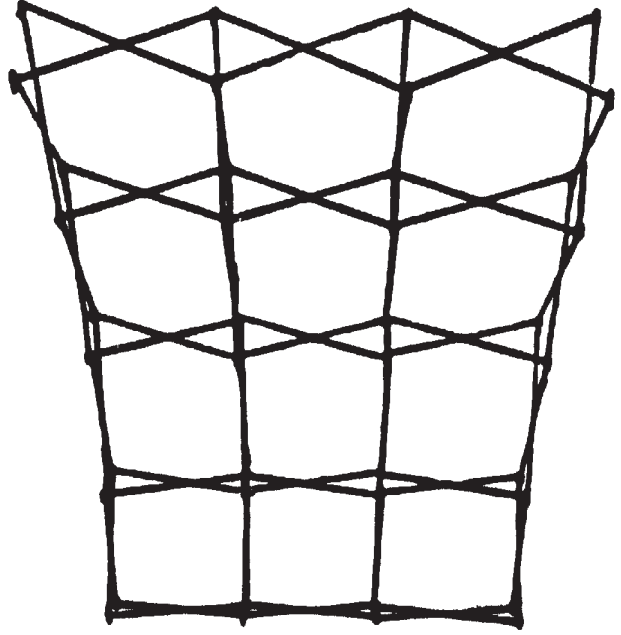
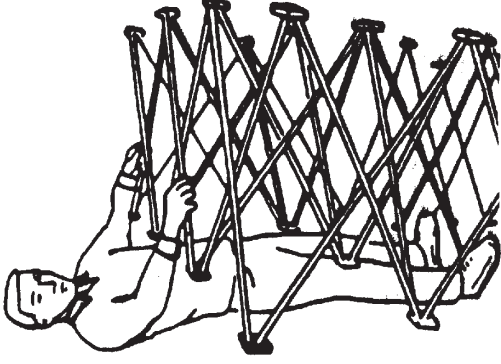

3. Attach all connectors together to stabilize the frame. (Note: To unlock, simply press the top of the connector.)



4. The hinged channel bar is set by expanding the top and bottom sections so the channel bar is vertically straight.

# Vision 2000 Pop-Up Display System

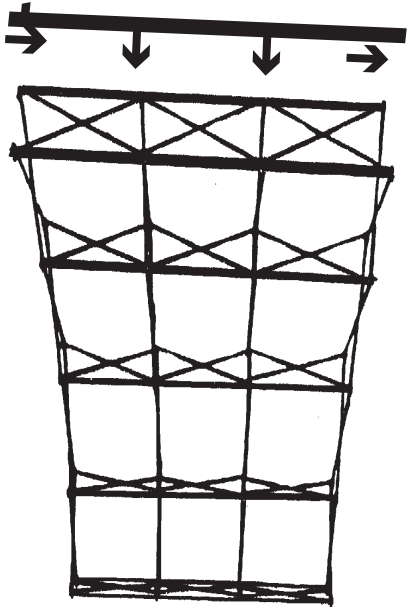

5. Slide the top of the channel bar onto the uppermost hub of the frame. Slide the bottom of the channel bar unto the bottom hub of the frame. Press the channel bar against each of the remaining hubs so they snap into place.
6. Unpack panels. Attach the end panels (these are smaller panels in the curve system) by hooking up the panels to the end screw on the channel bar at the corner of the frame and wrapping the panel around to hook on to the other corner screw on the channel bar located at the back corner of the frame. Align magnet.

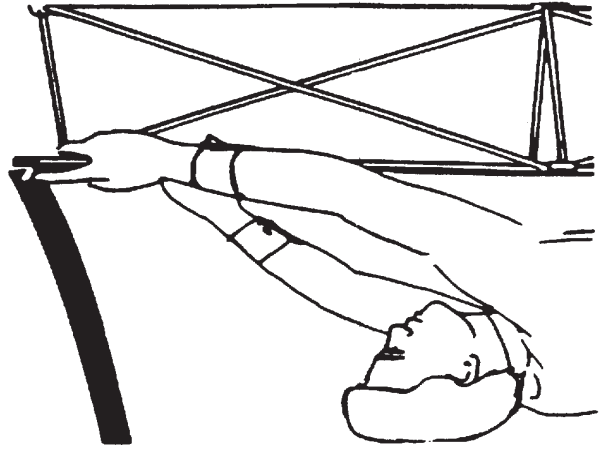
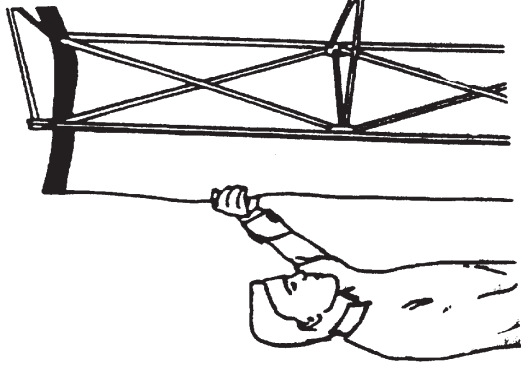

7. Attach the front panels to the front side of the frame by simply hooking up to the screw heads on the channel bars and aligning the magnet.
8. When repacking the panels make sure the fabric/graphic mural side is on the outside of the roll. Roll panels individually. **DO NOT** roll two or more panels together.
9. When removing the channel bar from the frame, unsnap it from the middle hubs by simply twisting it near each of the snap-on hubs. Then, gently push the bar upwards. **DO NOT** pull outwards.

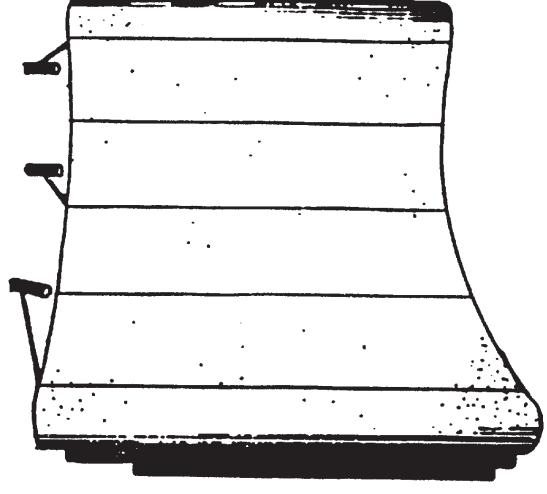

# VISION 1000/2000 Pop-Up Display System

## Curve Full Height (3 Quad) Panel

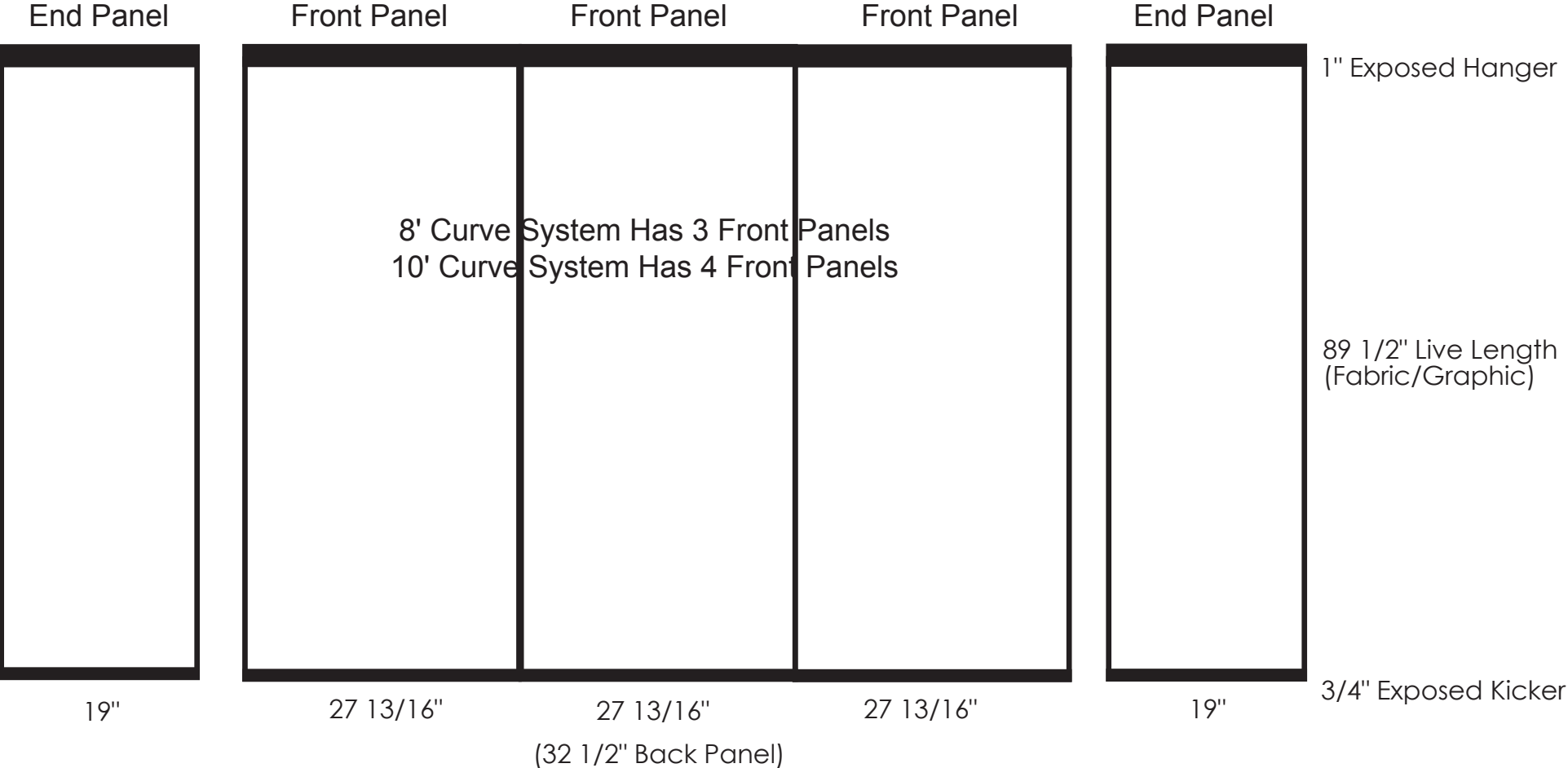
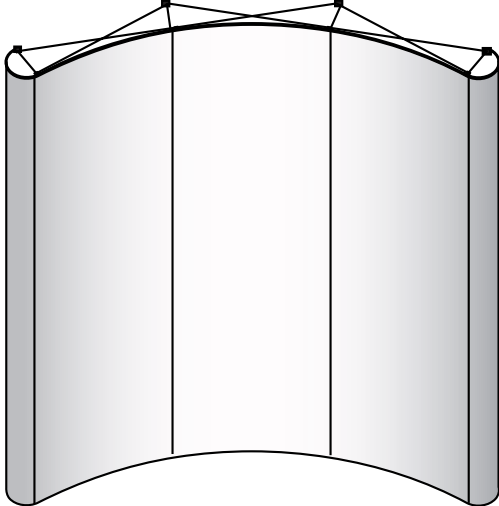

# OVAL PODIUM CONVERSION WRAP

---

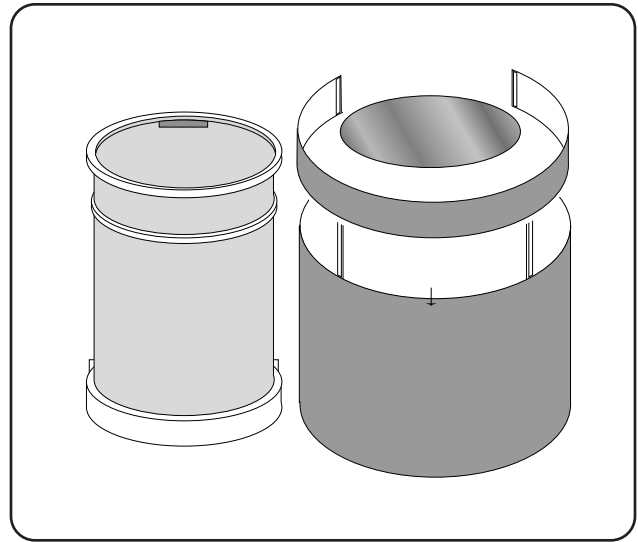

## Top Wrap



## Bottom Wrap

